

NOP Coolant Unit

C- Series CI

User's Instruction Manual

Important

Read this manual carefully and thoroughly for the correct and optimum use of NOP coolant unit. Improper use of the pump can cause personal injury and damage to property and may void the warranty.

**Save this manual for future reference, and keep
it readily available**

NOPTM
Nippon Oil Pump Co., Ltd.

User's Instruction Manual

User's Instruction Manual for NOP Coolant Unit C-Series CI

<Contents>



For Safe Operation	3
Safety Precautions	6
•Safety Devices.....	6
•Safety Measures.....	6
Model Numbering System	7
Pump Installation	7
•Place of Installation.....	7
•Space Required for Installation.....	10
•Position of Pump Inlet Port	10
Rc 3/8 Drain Piping	10
Filters	10
•Performance of Built-in Filter.	11
Contaminant Drain Port	11
Outlet Port	12
Piping for the Pump	12
•Torque Applied on Pipe Connection	12
•Connecting the Pipes.....	12
•Pipes and Pipe Joints	12
Electric Wiring	13
For Operation	13
•Start-up Checklist.....	13
•Test Run.....	13
Inspections	14
•Daily Startup Inspections	14
•Periodical Inspections	14
Storage	14
Warranty	15
For Selecting a Pump	15
•Operating Method.....	15
•Required Flow Rate.....	15
•Required Pressure	15
•Select Coolant Type	15
•Operating Ambient Temperatures	16
•Fluid Temperature Range	16
•Fluid Viscosity Range	16
•Compatible Work Materials.....	16
For Selecting a Motor	17

•Required Power for the Pump.....	17
•Voltage and Frequency	17
Suction Performance	17
Internal Construction	18
Troubleshooting Guide	19

For Safe Operation

Be sure to understand the safety countermeasures and strictly follow the precautions, and operating instructions stated in this manual for safe operation. When you see the following symbols and titles in this manual, be alert to the potential for personal injury or property damage.

This manual uses the following symbols and titles to identify the risk and danger levels.

 Danger:	A hazardous situation which, if not avoided, may result in death or serious injury.
 Warning:	A hazardous situation which, if not avoided, could result in death or serious injury.
 Caution:	A hazardous situation which, if not avoided, could result in injury or equipment damage.

 Danger
Do not operate the pump in a place having a risk of explosion or extremely dusty place. Do not place any flammable liquids or materials in the area surrounding the motor. Such items could cause explosion or fire.
Make sure that the power is disconnected before installing a pump, performing maintenance work or inspections to avoid the risk of electric shock.
Transporting, installation, plumbing, wiring, operation, or maintenance work must be performed by personnel specifically knowledgeable in the respective task, and any legally regulated work must be performed by personnel properly qualified under the related law.

 Warning
Getting your fingers, hands or articles caught in rotating or moving parts may cause an unexpected injury
The motor and pump surface may heat up while in an operation. Be careful not to touch the pump and motor while/or immediately after an operation.
Make sure that the power is disconnected before beginning to work on wiring. Also take measures to avoid accidental power-on.
Be sure to follow the instructions of the motor wiring diagram to prevent fire and electrical leakage.
Ground the equipment properly to prevent fire and electrical shocks due to electrical leakage.
Ensure the power is disconnected prior to performing maintenance work or inspections. Also take measure to prevent accidental power-on.
The pump cannot be used for volatile liquids like gasoline, nor fuel oils like kerosene. They may explode or cause fire.
Do not pump fluid over the specified temperature range. Leaked fluid may cause burns.

⚠ Caution

Be sure to use “Earth-Leakage Circuit Breaker (ELCB)” and overload protection device to avoid a damage to the equipment or motor burnout.

NOP coolant unit must not be operated outdoor.

Hoist the pump at designated lifting points. Check the lifting points on the drawing

Assembling the pump in a wrong orientation will damage the motor. Install the pump unit in an up-right position.

If the installation site is not level or if there is forcible installation in which the installation holes are not in exact alignment, the pump might be damaged due to vibration.

Tramp oil or foam may affect the pump performance. NOP coolant unit must not be installed in such environment.

Remove the large objects with pre-filtration device, such as a plate (screen-type) filter before the pump inlet. Recommended filter mesh size is 18 (about 1mm sieve size).

Suction of excessive amount of needle-like or wool-like metal chips may cause clogging on inlet port, Cyclone filter even when their particle sizes are smaller than 3 mm.

If you install additional in-line filter onto the outlet line, clean it regularly. Clogged filters affect the pump performance and abnormal noise, vibration or flow deficiency may occur.

Tramp oil or foam may affect cyclone filter performance. Installation of partition plate is recommended.

Diameter of contaminant drain piping must be the same as /or larger than contaminant drain port. Contaminant drain piping must not be higher than 1 M from the ground and not be longer than 3 M horizontally. The piping must be as short as possible. (PVC piping is recommended).

Inspect all valves, cocks, joints and the like before installation to avoid using any component that has a cavity in the casting.

Do not narrow the contaminant drain port. Excessive flow restriction($\leq 20\text{L/min}$) may decrease the pump performance and damage the pump.

A gate valve is highly recommended for a contaminant drain line.

Do not attach the end of contaminant drain line high above the tank liquid surface or nearby pump suction port. It may generate foam and suction of foam may cause flow deficiency in outlet line.

Be sure to follow the instruction of torque control specified on Table 3 on P12.

Do not use liquid type sealant. Do not use sealant tape too much. Excess use of sealant tape may result in over-torque and damage the port.

Do not attempt to flush out piping if already assembled with the pump.

Airtight test must be completed before installation.

Do not run the pump in reverse direction.

Do not run the pump dry over 10 second.

If an abnormal phenomenon is observed, stop the pump immediately and check for the defective areas. (See Table 4, P.19)

Do not use liquid that doesn't offer lubricity, rust protection (such as tap water) or contains corrosive substances. They will damage the pump.

⚠ Caution

Consult your coolant manufacturer (or distributor) for the compatibility with fluoro carbon rubber, the seal material of NOP pump, in advance to prevent leakage.

Operate the pump within the specified temperature range.

Keep the viscosity of your coolant within the specified range (up to 22 mm²/sec).

Do not use liquid beyond the specified viscosity range. It may reduce cyclone filter performance significantly and increase motor output.

Do not use work materials harder than HV600. Extremely hard materials, such as Inconel, Titanium alloys, Tungsten alloys, can drastically shorten your pump service-life.

Do not use hardened steel, carbon fiber, glass fiber contained materials, carbon materials. Those materials can drastically shorten your pump service-life.

Do not use film or resin coated materials. Those materials can easily clog the cyclone filter, leading to poor filter performance.

Do not apply wrong supply voltage or frequency

Keep the motor rotation speed within the specified range. (3000 min⁻¹ or less)

Make sure that there is no excess resistance in outlet line. It will affect the pump suction performance.

Entry of air into the inlet port will reduce suction performance.

Clean the perforated area of the inlet port at regular intervals. Clogged inlet will cause abnormal noise, vibration or discharge failure, which result in pump damage.

Do not run the pump against a closed outlet. Or it will result in pump or motor damage.

Safety Precautions

•Safety Devices

- Install “Earth-Leakage Circuit Breaker (ELCB)” or overload protection device on the motor power source without fail.
- Check the motor nameplate for the ratings, and set up and operate the motor within the specified ratings.
- Follow all the technical standards applicable to electrical facilities.

 **Caution:** Be sure to use “Earth-Leakage Circuit Breaker (ELCB)” and overload protection device to avoid a damage to the equipment or motor burnout.

- To avoid pump damage, install a flow monitor, pressure sensor, or such other devices in the pump’s outlet line to detect dry running.
- The oil seals and gaskets are not usable perpetually.
- Install the pump in a safe location, or provide a protective cover or device so that accidental oil leakage would not cause personal injury or equipment damage.

•Safety Measures

- Keep children or other people incapable of judging risks away from the pumps.
- Furnish a protective cover or device over the drive section to prevent your fingers, hands, or other articles from getting trapped into the section.

 **Warning** Getting your fingers, hands or articles caught in rotating or moving parts may cause an unexpected injury

- Do not contact a pump or motor during the operation, or immediately after the operation stops.

 **Warning** The motor and pump surface may heat up while in an operation. Be careful not to touch the pump and motor while/or immediately after an operation.

 **Danger** Do not operate the pump in a place having a risk of explosion or extremely dusty place. Do not place any flammable liquids or materials in the area surrounding the motor. Such items could cause explosion or fire.

Model Numbering System

Model Numbering System

TOP-YTH①②-③ C

① Motor capacity	1500: 1. 5kW
	3700: 3. 7kW
② Motor type	AC: AC 200/200/220/230 V 50/60/60/60 Hz 3 phase electric induction motor (IE3) with CE marking

③ Flow rate*	50 Hz	I155: Impeller pump (5 stages/150L)
	60 Hz	I152: Impeller pump (2 stages/150L)
	50 Hz	I305: Impeller pump (5 stages/300L)
	60 Hz	I302: Impeller pump (2 stages/300L)
Filtering method		C: cyclone type

*I155-I305 are not applicable to 60Hz

Pump Installation

Place of Installation

 Caution NOP coolant unit must not be operated outdoor.

 Caution Hoist the pump at designated lifting points. Check the lifting points on the drawing.

 Caution Assembling the pump in a wrong orientation will damage the motor. Install the pump unit in an up-right position.

 Caution If the installation site is not level or if there is forcible installation in which the installation holes are not in exact alignment, the pump might be damaged due to vibration.

 Caution Tramp oil or foam may affect the pump performance. NOP coolant unit must not be installed in such environment.

Figure 1: Pump Mounting Hole Patterns

CI 150L type has 2 mounting positions. Select either one of them considering the depth of your tank and the liquid level.

<CI 150Ltype>

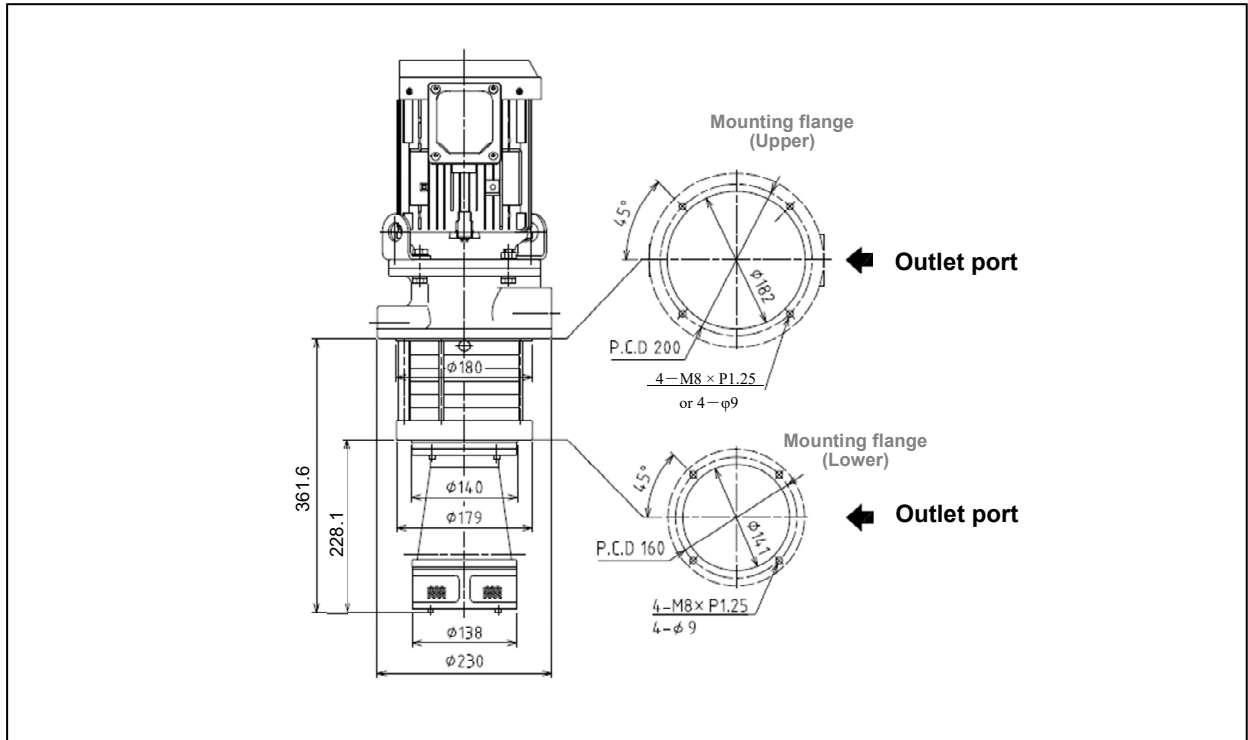

<CI 300L type>

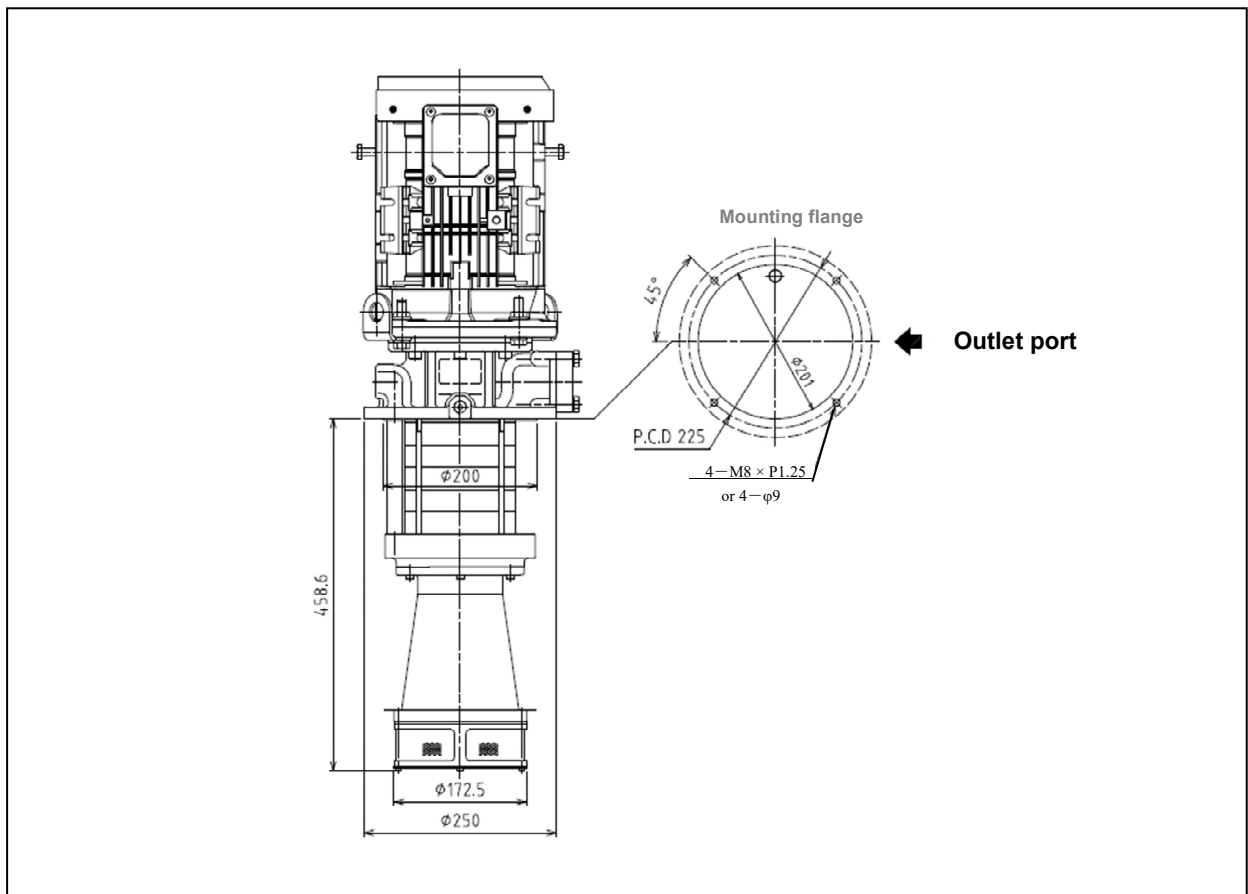
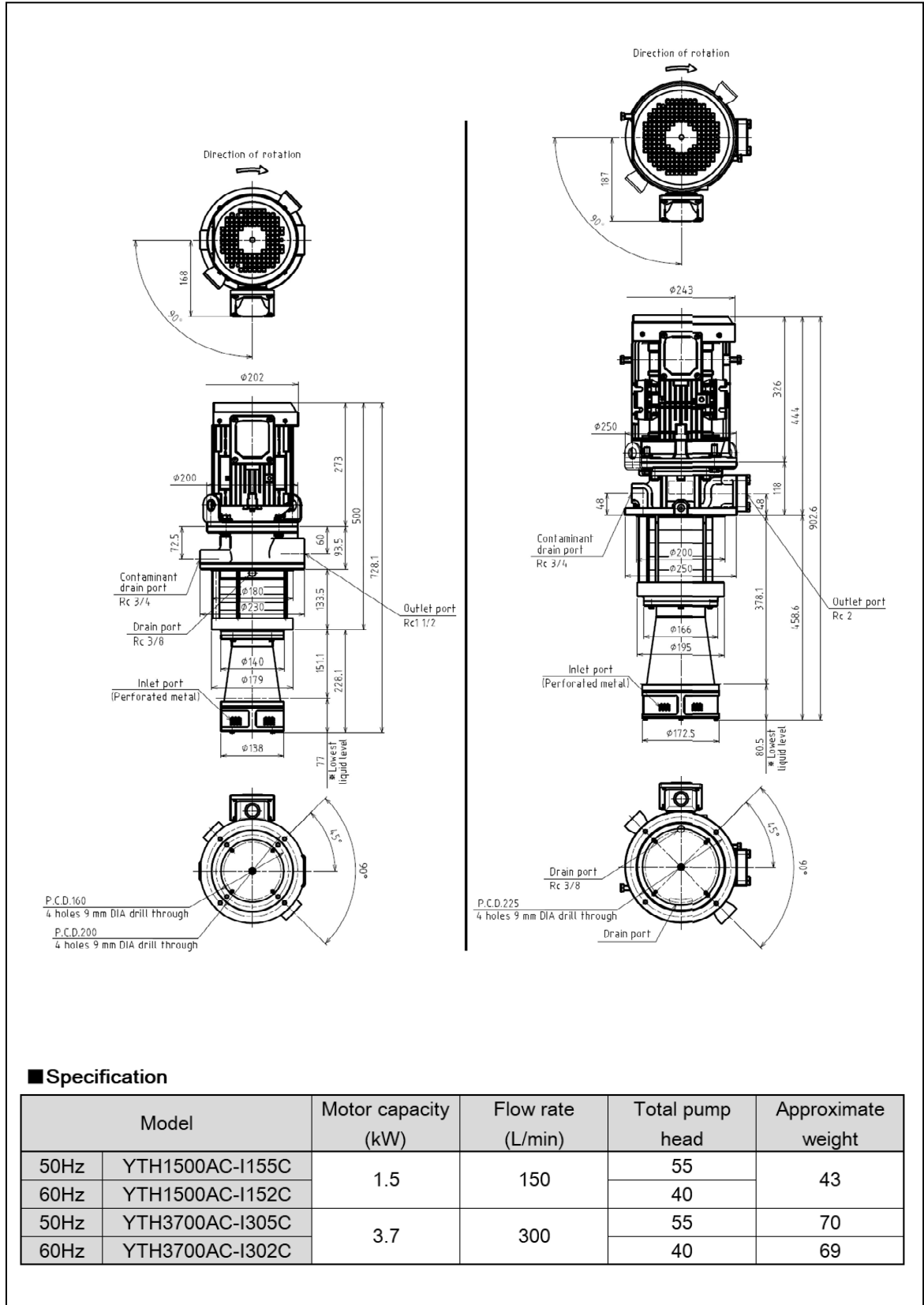

Figure 2: Pump Mounting Dimensions



Space Required for Installation.

Do not operate NOP coolant unit in a dusty, extremely high, or low temperature environment. (See P. 16 for the ambient temperatures.)

It is recommended to provide minimum clearances as illustrated in figure 3 for easy maintenance.

Figure 3: Required Clearances Around the Pump

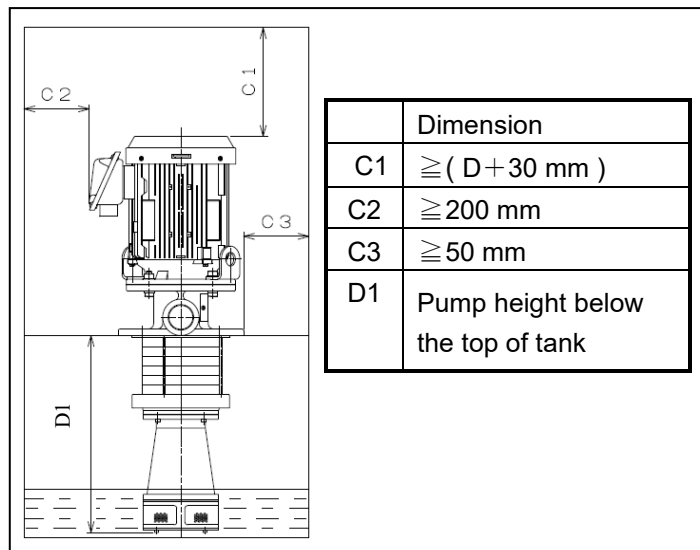

Position of Pump Inlet Port

Mount the pump in the tank at least 1 mm above the tank floor. This is to ensure enough clearance to prevent the pump from sucking the sediments of sludge or metal chips on the tank floor.

To prevent the pump from drawing air, install the pump in the tank water deeper than 77 mm as illustrated in figure 4.

Figure 4: Gap under the Bottom of Pump

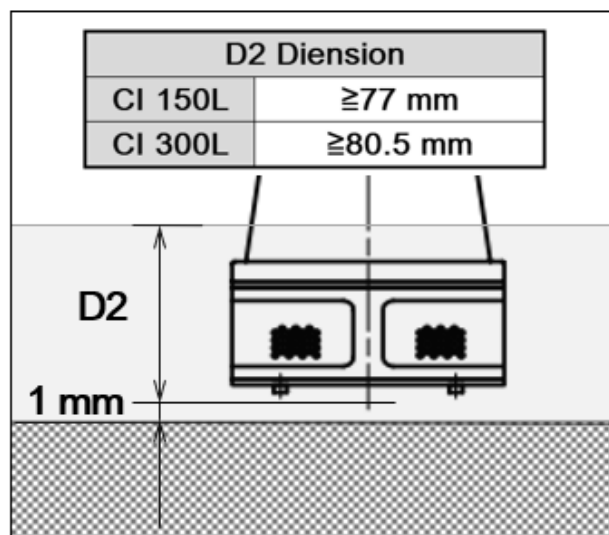

Rc 3/8 Drain Piping

If mounting the pump at lower flange, do proper drain piping so that the liquid from Rc 3/8 drain line smoothly flows into the tank.

Make sure that the pipe(hose) end doesn't contact the tank liquid surface.

Filters

⚠ Caution Remove the large objects with pre-filtration device, such as a plate (screen-type) filter before the pump inlet. Recommended filter mesh size is 18 (about 1mm sieve size).

All foreign objects larger than the perforations of the inlet port must be pretreated.

If higher filtration accuracy than shown in Table 1 on P11 is required, install in-line filter in the outlet line.

● **Performance of Built-in Filter.**

Table 1 : Filtering Performance (Nominal Value)

Cyclone filter	Water soluble coolant 100µm	99.9% (Specific weight 2.7)
	Straight oil	80% (Specific weight 2.7)
Inlet port	3mm (Solids larger than 3mm must be removed from the tank.)	



Caution

Suction of excessive amount of needle-like or wool-like metal chips may cause clogging on inlet port, Cyclone filter even when their particle sizes are smaller than 3 mm.



Caution

If you install additional in-line filter onto the outlet line, clean it regularly. Clogged filters affect the pump performance and abnormal noise, vibration and flow deficiency may occur.



Caution

Tramp oil or foam may affect cyclone filter performance. Installation of partition plate is recommended.

Contaminant Drain Port

- After being separated by a cyclone filter, contaminant-contained dirty coolant will be discharged from the contaminant drain port.
- Filtering the dirty liquid discharged from the contaminant drain line will help maintain the liquid in the tank clean

Table 2: Contaminant Drain Port Performance

Model	Flow rate	Discharge pressure
I155	20~35 L/min	0.02 MPa
I152	25~40 L/min	
I305	45~60 L/min	
I302	50~70 L/min	

*These values are for reference only and not for guaranteeing the performance.



Caution

Diameter of contaminant drain piping must be the same as /or larger than contaminant drain port.
 Contaminant drain piping must not be higher than 1 M from the ground and not be longer than 3 M horizontally. The piping must be as short as possible. (PVC piping is recommended).



Caution

Inspect all valves, cocks, joints and the like before installation to avoid using any component that has a cavity in the casting.



Caution

Do not narrow the contaminant drain port. Excessive flow restriction(≤ 20 L/min) may decrease the pump performance and damage the pump.



Caution

A gate valve is highly recommended for a contaminant drain line.



Caution

Do not attach the end of contaminant drain line high above the tank liquid surface or nearby pump suction port. It may generate foam and suction of foam may cause flow deficiency in outlet line.

Outlet Port

- Pipes connected to the outlet port must be as large as the port diameter and pressure resistant type.

Piping for the Pump

●Torque Applied on Pipe Connection

The maximum torques permissible for pipe connections to NOP coolant unit are given in the table that follows:

Table 3: Maximum Permissible Torque by the Pipe Size

Pipe size, Rc	1 – 1/2"	3/4"	3/8"
Torque N·m	150	60	30



Caution

Be sure to follow the instruction of torque control above.



Caution

Do not use liquid type sealant. Do not use sealant tape too much. Excess use of sealant tape may result in over-torque and damage the port.

●Connecting the Pipes

- To prevent leaks and air entry, make sure all pipe connections are securely tightened and completely sealed.
- Be sure to use pipe-supports so that the pipes are self-supported and no weight will be placed on the pump.
- Make sure that the pipe lengths and angles are correct when assembled so that no unnecessary strain is placed on the pump.
- Installation of a pressure gauge is highly recommended as pump conditions can be easily monitored.
- Installation of a stop valve, union joints, and such other fittings are also recommended for easy maintenance.

•Pipes and Pipe Joints

- Be sure to flush out all pipes to ensure that they are thoroughly clean before use.

 **Caution** Do not attempt to flush out piping if already assembled with the pump.

 **Caution** Airtight test must be completed before installation.

Electric Wiring

Electric wiring must be carried out by qualified personnel.

 **Warning** Make sure that the power is disconnected before beginning to work on wiring. Also take measures to avoid accidental power-on.

 **Warning** Be sure to follow the instruction of the motor wiring diagram to prevent fire and electrical leakage.

 **Warning** Ground the equipment properly to prevent fire and electrical shocks due to electrical leakage.

- Check the direction of the motor rotation. If using NOP's pre-installed motor, the motor rotation is indicated on the wiring plate on the motor frame or terminal box. Connect the motor accordingly.
(Our NOP's pre-installed motor (3-phase type) is, when viewed from the suction side, designed to rotate in counter-clockwise if wired as illustrated in the figure.5.)

Figure 5: Motor Wiring Diagram

For Operation

•Start-up Checklist

- Is the tank filled with liquid up to, or over the specified level? (See Fig.4, P10)
- Are the inlet, outlet and drain ports unblocked?
- Check for loose pipe connections.
- On the initial startup, turn the pump on and off quickly to confirm that the motor is running in the correct direction.



 **Caution** Do not run the pump in reverse direction.

•Test Run

 **Caution** Do not run the pump dry over 10 second.

Inspections

●Daily Startup Inspections

Check for liquid leakage, abnormal sound, and heating.



Caution

If an abnormal phenomenon is observed, stop the pump immediately and check for the defective areas. (See Table 4, P.19)

●Periodical Inspections

·Periodical inspection must be performed at least once a year.

<Periodical Inspection Checklist>

- Flow rate, pressure in outlet port
- Flow rate in contaminant drain port (Guideline: 20 L/min, minimum)
- Clogging of contaminant drain port
- Clogging of the inlet port (perforated metal)
- Leaks from pipe connecting parts
- Minimum coolant level in the tank (Keep the level high enough to prevent air entry)
- Amount of contaminant in the tank (It is recommended to perform tank cleaning at least once in a half year)
- Concentration level of the coolant (Keep the level within the range specified by the coolant manufacturer)
- Viscosity of straight oils (22 mm²/sec or less) .
- Liquid temperature (-5°C ~ 60°C)
- Over-heating of pump motor

Storage

- It is always good to keep replacement parts on hand (pump, motor and coupling) to minimize downtime due to unexpected pump failure or deterioration.
- Be sure to perform a periodical inspection.
(See “Periodical inspection” above)
- If the pump is to be stored for an extended period of time, take the following steps to protect the pump against the internal rust.
 - ① Pump lubricating oil of 15 mm²/s or less viscosity for three minutes to wet inside the pump.
 - ② Put lids on the ports, wrap the unit in a plastic bag, sealed it air-tight and store.
- If storing for six months or longer, check for exterior rust and free rotation once a month.
- If you reuse the pump long after storage, check for unusual noise, heating, and other abnormalities on the first run. When any of these mentioned above occurs, stop operation immediately.



Warning

Ensure the power is disconnected prior to performing maintenance work or inspections. Also take measure to prevent accidental power-on.

Warranty

- NOP coolant unit is warranted to be free from defects in workmanship and materials for **one year from the date we ship to customer's designated location, or 5000 hours of operation, whichever occurs first.**
- The warranty will not cover failures or damages caused by not following the guidelines stated in this manual, improper use, lack of appropriate maintenance, natural disaster, accidents or act of God.
- Any disassembly, alteration made to a product by the customer will void the warranty.
- The warranty will only apply to the products you purchased and not apply to indirect or consequential loss or damage resulting from the use of this product.

For Selecting a Pump

●Operating Method

- The pump must be run under continuous operation. Reduce the number of ON/OFF cycles to a minimum if intermittent operation is unavoidable.

●Required Flow Rate

- Select a pump by referring to the catalog, drawings, or other materials.
- Note that discharge rate is subject to the pump type, temperature, and pressure of the fluid.
- Select a pump with an adequate margin of outlet pressure and flow rate.

●Required Pressure

- Select a pump by referring to the catalog, drawings and other material.
Note: The pump must be run within the maximum pump operating pressure and the motor output rating.

●Select Coolant Type

Water-soluble coolants or straight oils with kinematic viscosity of 22 mm²/sec or less.



Caution

Do not use liquid that doesn't offer lubricity, rust protection (such as tap water) or contains corrosive substances. They will damage the pump.



Caution

Consult your coolant manufacturer (or distributor) for the compatibility with fluoro carbon rubber, the seal material of NOP pump, in advance to prevent leakage.



Warning

The pump cannot be used for volatile liquids like gasoline, nor fuel oils like kerosene. They may explode or cause fire.

•Operating Ambient Temperatures

·The permissible ambient temperature range is between -10°C and 40°C.

 Caution Operate the pump within the specified temperature range.

•Fluid Temperature Range

·The permissible temperature range for the liquid is between -5°C and 60°C.
·When start-up, keep the temperature gap between the liquid and ambient temperature within 40°C.

 Warning Do not pump fluid over the specified temperature range. Leaked fluid may cause burns.

•Fluid Viscosity Range

·The permissible viscosity range is 22 mm²/sec or less

 Caution Keep the viscosity of your coolant within the specified range.
(up to 22 mm²/sec)

 Caution Do not use liquid beyond the specified viscosity range. It may decrease cyclone filter performance significantly and increase motor output.

Note: Low temperature in winter must be taken into account when setting fluid temperature as viscosity increases rapidly when temperature decreases.

•Compatible Work Materials

·Maximum permissible hardness of work materials is within HV 600

 Caution Do not use work materials harder than HV600. Extremely hard materials, such as Inconel, Titanium alloys, Tungsten alloys, can drastically shorten your pump service-life.

 Caution Do not use hardened steel, carbon fiber, glass fiber contained materials, carbon materials. Those materials can drastically shorten your pump service-life.

 Caution Do not use film or resin coated materials. Those materials can easily clog the cyclone filter, leading to poor filter performance.

For Selecting a Motor

•Required Power for the Pump.

- Select a pump with an adequate margin with reference to the performance curve in the catalog.
- The power required by a pump is subject to the pressure, flow rate and viscosity of the liquid.
- A liquid with higher viscosity requires a greater power.

Note: Low temperature in winter must be taken into account when selecting motor, as viscosity rapidly increases when temperature drops.

•Voltage and Frequency

 Caution Do not apply wrong supply voltage or frequency

 Caution Keep the motor rotation speed within the specified range.
(3000 min⁻¹ or less)

Suction Performance

The pump performance will be reduced by resistance in the inlet line or air suction. Pay attention to the coolant surface level of a tank and clogging in inlet port (Perforated metals).

 Caution Make sure that there is no excess resistance in outlet line. It will affect the pump suction performance.

 Caution Entry of air into the inlet port will reduce suction performance.

 Caution Clean the perforated area of the inlet port at regular intervals. Clogged inlet will cause abnormal noise, vibration or discharge failure, which result in pump damage.

 Caution Do not run the pump against a closed outlet. Or it will result in pump or motor damage.

Internal Construction

Figure 6 : Pump Parts Name

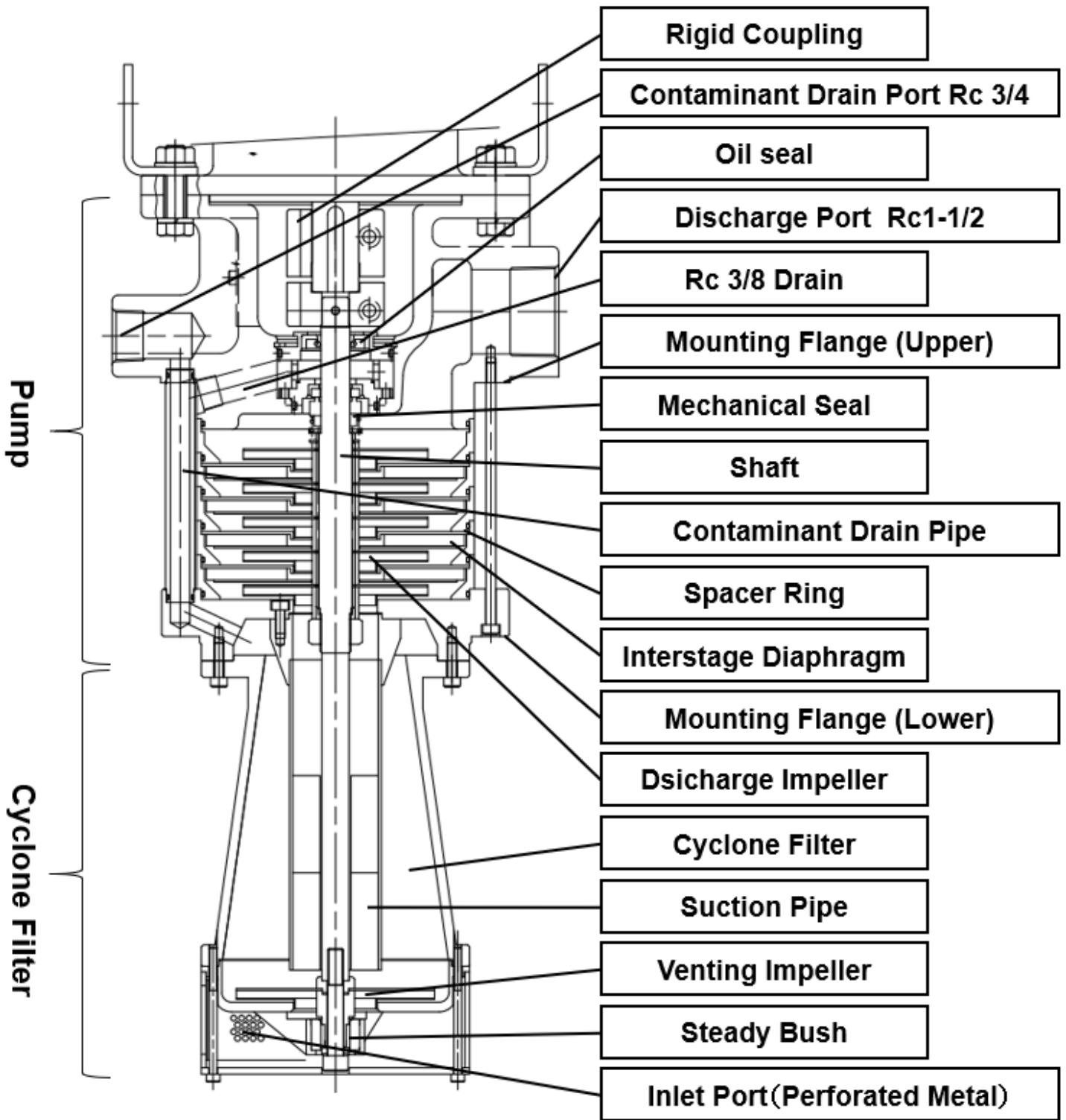

Troubleshooting Guide

If you experience no oil discharge, a high-pitched sound, or such other abnormal phenomena soon after the installation, check the troubleshooting chart in the table that follows.

If you cannot find out the cause of trouble, consult us or a dealer.

Table 4: Pump Troubleshooting Chart

Symptom	Possible causes	Check methods	Possible remedies
No discharge from outlet port. Insufficient flow or pressure. Abnormal noise.	Motor failure.	Are wires at motor loose or disconnected? Do operation test for motor individually.	• Repair or replace pump.
	Motor is wired incorrectly or disconnected.	Are wires at motor loose or disconnected? Check direction of rotation.	• Rewire motor in a correct rotation indicated on label.
	Coupling is damaged.	Check connected area between pump and motor.	• Replace coupling.
	Liquid surface level decreases.	Check liquid amount in tank.	• Refill tank with enough liquid. • Control liquid level with level sensor.
	Inlet port is clogged.	Check the inlet port for clogging.	• Periodical cleaning on and around inlet port. • Insert a plate filter prior to the inlet port as a pre-filtration.
	Air drawn into pump or pipes.	• On the first-run, after long term storage or immediately after replacing coolant liquid, pump often doesn't discharge due to the trapped air.	• Perform air-bleeding on pump or piping. Perform air-bleeding in front of check valve if the one is installed in outlet line.
	Clogging or failure of impellers.	• Check the impellers for clogging or damage.	• Remove accumulated swarf. • Repair or replace pump.
	Aeration.	• Is pump sucking foam or air?	• Take measures to prevent suction of air or tramp oil. (ex. Change pump location, use partition or defoamer)
Pipes connected to outlet port is too large.	Is outlet discharge flow rate sufficient?	• Use smaller pipes.	
No discharge from contaminant drain port	Contaminant drain port piping is too long or too high.	Pull off a pipe from the contaminant drain port and check if liquid is being delivered properly or not.	Piping must be no higher than 1 m from the tank bottom vertically, and no longer than 3 m horizontally.
	Clogging of contaminant drain port.	Check inside the pipe for clogging.	• Clean inside the pipe periodically. • Minimize the number of bends in your pipe layout. • Use larger pipe.
	Clogging inside the cyclone	Check inside the cyclone for clogging.	• Remove swarf. • Repair or replace pump.
	Clogging or failure of impellers.	Check the impellers for clogging or damage.	• Remove swarf. • Repair or replace pump.
Liquid leaks.	Oil seal deterioration or damage.	Does liquid leak from drain port (Rc 3/8)?	Repair seal. Repair or replace pump.
	gasket deterioration or damage.	Does liquid leak from connected area?	Repair or replace pump.
Breaker or thermal trips out.	• Motor failure. • Wiring errors.	• Check motor wiring. • Does motor start?	• Rewire motor. • Repair or replace motor.
	Overloading.	Are motor output rating and coolant viscosity adequate?	• Use motor with higher output rating. • Use pump with lower capacity. • Lower the pressure setting. • Change the coolant types.
	Coolant type is incompatible. (Viscosity is too high, lubricity insufficient, Pump failure)	• Is motor rotating? • Are liquid viscosity and lubricity adequate? • Is there abnormal noise?	• Repair or replace pump. • Change the types of coolant you use.

NOP Nippon Oil Pump Co., Ltd. Rev. No : ACI202003

For further information :
HP : <http://www.nopgroup.com>

Tel : +81-3-6402-4041
Fax : +81-3-3436-1777

Sumitomo Real Estate Higashi Shimbashi
Building-6. 3F, 1-2-4 Hamamatsucho,
Minato-ku, Tokyo, Japan 105-0013

Your dealer :