

NOP Filter Pump

YTH-CT

User's Instruction Manual

Important

Read this manual carefully and thoroughly for the correct and optimum use of NOP filter pump. Improper use of the pump can cause personal injury and damage to property and may void the warranty.

**Save this manual for future reference, and keep
it readily available**



Nippon Oil Pump Co., Ltd.



YTH-CT User's Instruction Manual

< Contents >

Safety Precautions.....	5
•Safety Equipment.....	5
•Safety Measures	5
Model Numbering System.....	6
Pump Installation	6
•Installation Site.....	6
•Required Space for Installation.....	8
•Recommended Installation Circuit.	8
Position of Pump Inlet Port.....	8
Filters.....	8
•Performance of Cyclone Filter	9
Contaminant Drain Line	9
Outlet Port	10
Piping for the Pump	11
•Torque Applied on Pipe Connection	11
•Connecting the Pipes	11
•Pipes and Pipe Joints.....	11
Electric Wiring.....	12
For Operation.....	12
•Start-up Checklist.....	12
•Test Run	12
Inspections	13
•Daily Startup Inspections.....	13
•Periodical Inspections	13
Storage.....	13
Warranty.....	14
For Selecting a Pump	14
•Operating Method	14
•Required Flow Rate.....	14
•Required Pressure	14
•Relief Valve Pressure Setting.....	14
•Selecting Coolant Type and Viscosity Range.	14
•Operating Ambient Temperatures.....	15
•Fluid Temperature Range.....	15
•Compatible Work Materials.....	15
Motor Selection.....	16
•Required Power for the Pump.	16
• Voltage and Frequency	16
Suction Performance	17
Internal Structure	17
Troubleshooting Guide.....	18

Be sure to understand the safety regulations and follow the precautions and operating instructions stated in this manual for safe operation. When you see the following symbols and titles in this manual, be alert to the potential for personal injury or property damage.

This manual uses the following symbols and titles to identify the risk and danger levels.

 Danger:	A hazardous situation which, if not avoided, may result in death or serious injury.
 Warning:	A hazardous situation which, if not avoided, could result in death or serious injury.
 Caution:	A hazardous situation which, if not avoided, could result in injury or equipment damage.

 Danger
Do not operate the equipment in a place having a risk of explosion or extremely dusty place. Do not place any flammable liquids or materials in the area surrounding the motor. Such items could cause explosion or fire.
Make sure that the power is disconnected before installation, maintenance or inspections to avoid the risk of electric shock.
Transporting, installation, plumbing, wiring, operation, or maintenance work must be operated by personnel specifically knowledgeable in the respective task, and any legally regulated work must be performed by personnel properly qualified under the related law.

 Warning
Getting your fingers, hands or articles caught in rotating or moving parts may cause an unexpected injury.
The motor and pump surface may heat up while in an operation. Be careful not to touch the pump and motor while/or immediately after an operation.
Ensure the power is disconnected prior to any wiring works. Take measures to avoid accidental power-on.
Be sure to follow the instruction of the motor wiring diagram to prevent fire and electrical leakage.
Ground the equipment properly to prevent fire and electrical shocks due to electrical leakage.
The pump cannot be used for gasoline and other volatile liquids. They may cause an explosion or fire.
Do not pump fluid over the specified temperature range. Leaked fluid may cause burns.

⚠ Caution

Be sure to use “Earth-Leakage Circuit Breaker (ELCB)” and overload protection device to avoid a damage to the equipment or motor burnout.

NOP filter pump must not be operated outdoor.

Hoist the pump at designated lifting points. Check lifting points on the drawing.

Assembling the pump in a wrong orientation will damage the motor. Install the pump unit in an up-right position.

If the installation site is not level or if there is forcible installation in which the installation holes are not in exact alignment, the pump might be damaged due to vibration.

Tramp oil or foam may affect the pump performance. NOP filter pump must not be installed in such environment.

A pre-filtration device, such as a plate (screen-type) filter must be installed to remove the large objects prior to the pump inlet. Recommended filter mesh size is 18 (about 1mm sieve size).

Suction of excessive amount of needle-like or wool-like metal chips may cause clogging on inlet port and discharge impeller even when their particle sizes are smaller than 3 mm.

If you install additional in-line filter onto the outlet line, clean it regularly. Clogged filters affect the pump performance and abnormal noise, vibration or flow deficiency may occur.

Diameter of contaminant drain piping must be the same as /or larger than contaminant drain port. Contaminant drain piping must not be higher than 1 M from the ground and not be longer than 3 M horizontally. The piping must be as short as possible. (PVC piping is recommended). See figure 5 on P.10 for the sample piping layout.

Inspect all valves, cocks, joints and the like before installation to avoid using any component that has a cavity in the casting.

Do not narrow the contaminant drain port. Excessive flow restriction($\leq 20\text{L}/\text{min}$) may decrease the pump performance and damage the pump.

A gate valve is highly recommended for a contaminant drain line

Contaminant drain line must be assembled below the coolant surface level as shown on figure 5 on P.10 to ensure that air doesn't enter the system.

Make sure there is no blocking or clogging in contaminant drain line.

Do not return contaminant drain piping into the coolant tank.

Be sure to follow the instruction of torque control.

⚠ Caution

Do not use liquid type sealant. Avoid using too much sealant tape. Excess use of sealant tape may result in over-torque and damage the port.

Do not attempt to flush out piping if already assembled with the pump.

Airtight test must be completed before installation.

Do not run the pump in reverse direction.

Do not run the pump dry over 10 seconds

Be sure to bleed an outlet piping of air on a initial run.

If any abnormalities are discovered, stop the pump immediately and inspect for the defective areas. (See Table 5 P.18)

Do not run the pump over the maximum pressure setting.

Do not remove the return pipe, or it may cause foam and abnormal sounds

Consult your coolant manufacturer (or distributor) for the compatibility with fluoro carbon rubber, the material of the pump seal, in advance to prevent leakage.

Operate the pump within the specified temperature range.

See "Operating Ambient Temperatures" and "fluid temperature range" on P.15

Keep the viscosity of your coolant within the specified range.

See "Table 4 : Compatible Coolant Type and Viscosity Range on P.15.

Do not use work materials harder than HV300. Extremely hard materials, such as Inconel, Titanium alloys, Tungsten alloys, can drastically shorten the pump service-life.

Do not use materials containing Si over 6 %, such as Aluminum Die Cast (ADC), Ductile. Those materials can drastically shorten your pump service life.

Do not use hardened steel, carbon fiber, glass fiber contained materials, carbon materials. Those materials can drastically shorten your pump service-life.

Do not use film or resin coated materials. Those materials can lead to poor filter performance and clogging in the cyclone filter.

Do not operate the pump in a fluid containing a large amount of grindstones or abrasive grains. They can drastically shorten your pump service-life.

Do not apply wrong supply voltage or frequency.

Keep the motor rotation speed within the specified range. (1000 min⁻¹ to 2000 mm⁻¹)

Make sure that there is no excess resistance in outlet line. It will affect the pump suction performance.

Clean the perforations of the inlet port at regular intervals. Clogged inlet will cause abnormal noise, vibration, discharge failure, which result in the pump damage.

Safety Precautions

● Safety Equipment

- Be sure to equip motor with an “Earth-Leakage Circuit Breaker (ELCB)” or overload protection equipment.
- Use this equipment only after confirming that the ratings are within the prescribe ratings stated on the motor’s name plate.
- Be sure to comply with local electrical codes and regulations.



Caution:

Be sure to use “Earth-Leakage Circuit Breaker (ELCB)” and overload protection device to avoid a damage to the equipment or motor burnout.

- Install a galvanometer, pressure sensor, or such other devices in the pump’s outlet line to avoid dry running.
- The oil seals and gaskets cannot be used perpetually.
- To prevent motor damage from coolant leak, it is recommended to insert a drain hose into seal drain hole.
- To avoid motor damage, drain hose should be inserted in a way that the coolant can naturally flow down by its own weight through the hose.
- Install the pump in a safe location, or provide a protective cover or device to avoid accidental coolant leakage.

● Safety Measures

- Keep children or other people incapable of judging risks away from the pumps.
- Install protective device to prevent fingers, hands or other objects from getting caught in the rotating or moving parts.



Warning

Getting your fingers, hands or articles into driven parts may cause an unexpected injury

- Do not touch a pump or motor during or immediately after the operations.



Warning

The motor and pump surface may heat up while in an operation. Be careful not to touch the pump and motor while/or immediately after an operation.



Danger

Do not operate the pump in a place having a risk of explosion or extremely dusty place. Do not place any flammable liquids or materials in the area surrounding the motor. Such items could cause explosion or fire.

Model Numbering System

TOP-YTH①②-③CVD④

①Motor capacity	750 : 0.75 kW		Filtering method	C : Double-cyclone type
	1500 : 1.5 kW			Relief valve
②Motor type*1	Standard motor	A3: AC200/200/220/230 V 50/60/60/60 Hz 3 phase electric induction motor(IE3) with CE marking	④Relief pressure setting	20 : 2.0 MPa
	Local motor	AE : supplied by NOP Deutschland (Germany) AF : supplied by NOP Taiwan AJ : supplied by NOP Asia (China) AK : supplied by NOP India		15 : 1.5 MPa
③Flow rate	T208	: Trochoid pump 8 cc/rev		
	T216	: Trochoid pump 10 cc/rev		

*1 For further details about the local motor, please contact our overseas branch or subsidiaries.

Pump Installation

●Installation Site

⚠ Caution NOP filter pump must not be operated outdoor.

⚠ Caution Hoist the pump at designated lifting points. Check the lifting points on the drawing.

⚠ Caution Assembling the pump in a wrong orientation will damage the motor. Install the pump unit in an up-right position.

⚠ Caution If the installation site is not level or if there is forcible installation in which the installation holes are not in exact alignment, the pump might be damaged due to vibration.

⚠ Caution Tramp oil or foam may affect the pump performance. NOP filter pump must not be installed in such environment.

Figure1 : Pump Mounting Pattern

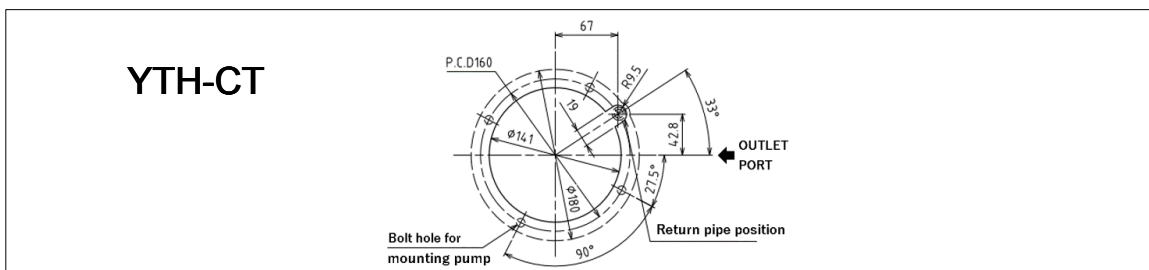
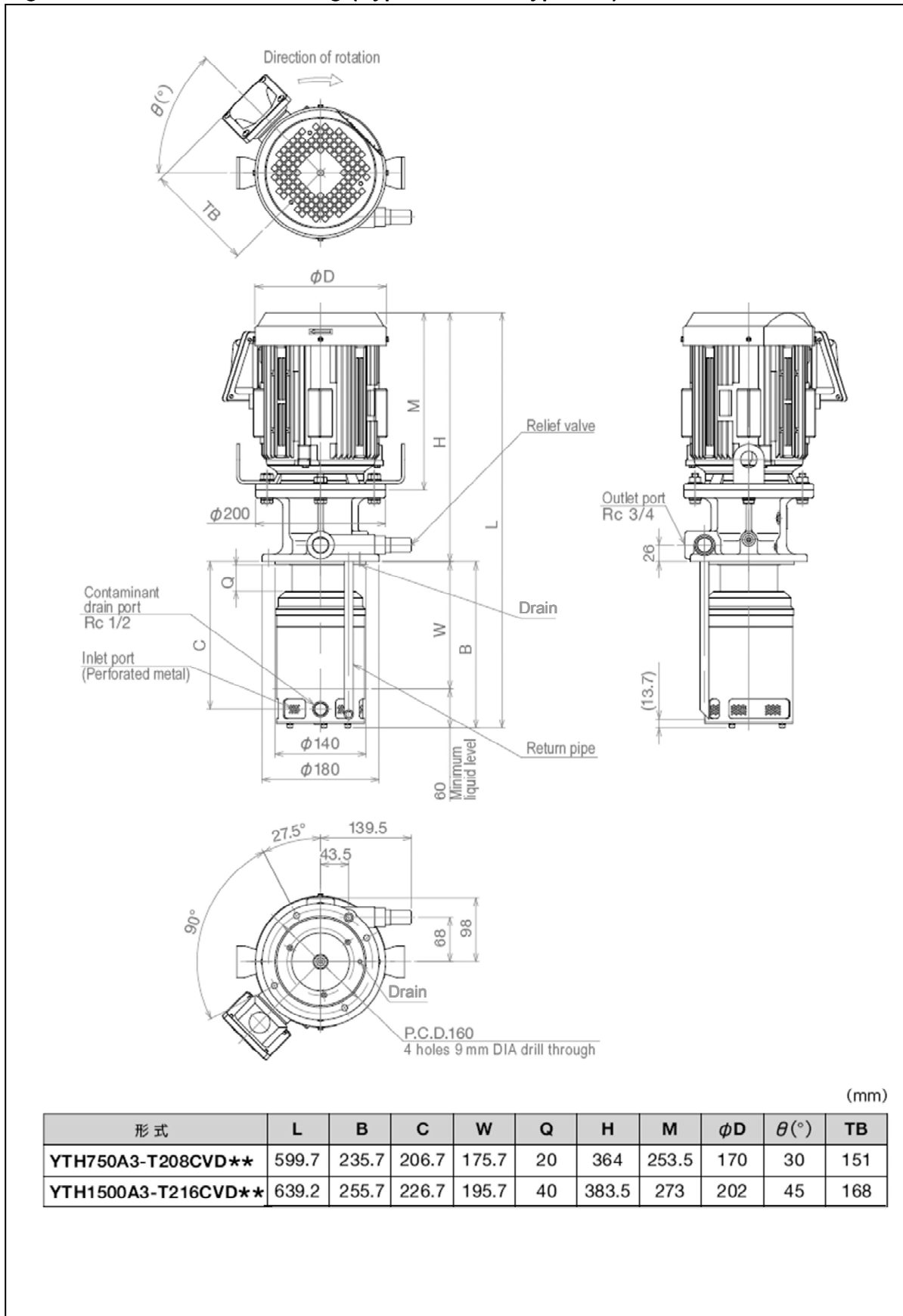

Figure 2 : Dimensional drawing (Typical / Motor type: A3)



•Required Space for Installation

Do not install NOP filter pump in extremely dusty, high, or low temperatures location.

(See P.15 for “Operating ambient temperatures”)

Provide minimum clearances as illustrated in the figure 3 to ensure enough space for maintenance work.

•Recommended Installation Circuit.

It is recommended to install a circuit as illustrated below for safe and efficient operation, particularly, piping for air-bleeding in the pump’s outlet line.

Figure 3: Clearances Required Around the Pump (Typical)

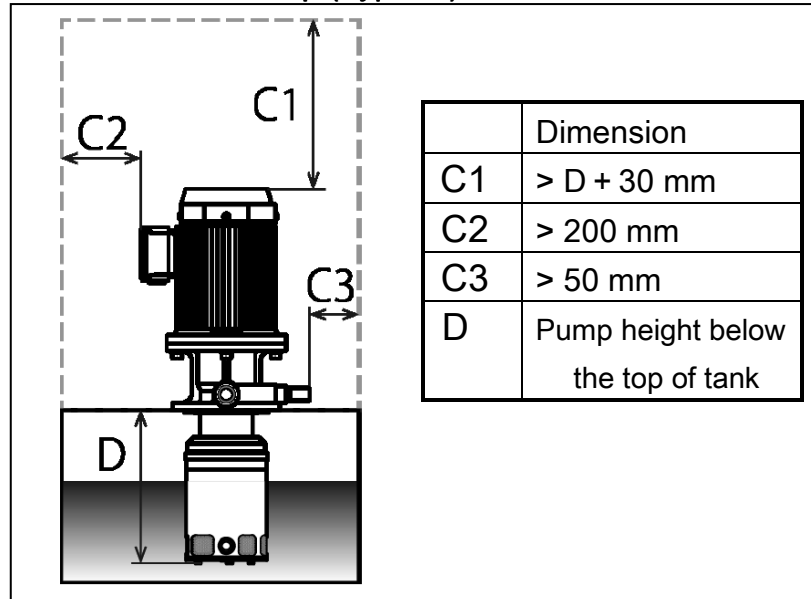

Position of Pump Inlet Port

Mount the pump in the tank at least 1 mm above the tank floor. This is to ensure the enough clearance to prevent the pump from sucking the sediments of sludge or metal chips on the tank floor.

To prevent the pump from drawing air, install the pump in the tank water deeper than 60 mm as illustrated in figure 4.

Figure 4 : Gap under the Pump Bottom (Typical)

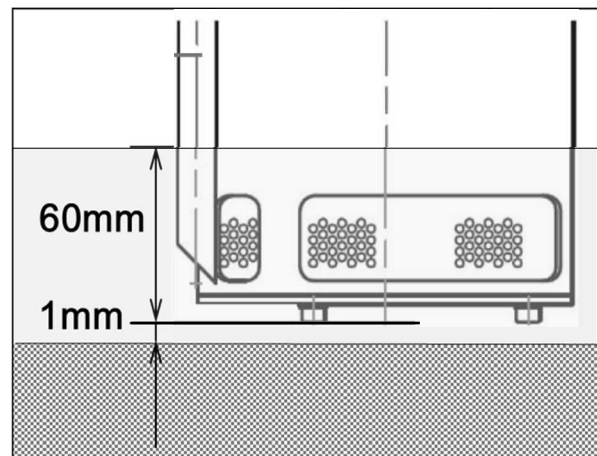

Filters



Caution

Remove the large objects with pre-filtration device, such as a plate (screen-type) filter before the pump inlet. Recommended filter mesh size is 18 (about 1mm sieve size).

All foreign objects larger than the perforations of the inlet port (3 mm) must be pre-filtered. If you require higher filtration accuracy than shown in Table 1, install additional in-line filter in the outlet line.

●Performance of Cyclone Filter

Table.1 Filtration Performance

Inlet port	3mm (Solids larger than 3mm must be removed from the tank.)
Cyclone filter (Nominal value)	50 μm : 95% (Relative density: 2.7) 100 μm : 99% (Relative density: 2.7)

⚠ Caution Suction of excessive amount of needle-like or wool-like metal chips may cause clogging on inlet port and discharge impeller even when their particle sizes are smaller than 3 mm.

⚠ Caution If you install additional in-line filter in the outlet line, clean it regularly. Clogged filters affect the pump performance and abnormal noise, vibration or flow deficiency may occur.

Contaminant Drain Line

- After filtered by cyclone filter, cleaned coolant will be delivered from the outlet port while the dirty coolant will be discharged from the contaminant drain port.
- Collect the metal chips discharged from the contaminant drain port by bucket, magnet separator or some other devices. It will help maintain the tank coolant clean.

Table 2 : Contaminant Drain Port Performance (for reference only) *

Flow rate	30 to 40 L/min
Pressure	0.02 MPa

* The values above are for reference only and not for guaranteeing the performance.

⚠ Caution Diameter of contaminant drain piping must be the same as /or larger than contaminant drain port.
Contaminant drain piping must not be higher than 1 M from the ground and not be longer than 3 M horizontally. The piping must be as short as possible. (PVC piping is recommended).
See figure 5 on P.10, for the sample piping layout.

⚠ Caution Inspect all valves, cocks, joints and the like before installation to avoid using any component that has a cavity in the casting.

⚠ Caution Do not narrow the contaminant drain port. Excessive flow restriction ($\leq 20\text{L/min}$) may decrease the pump performance and damage the pump.

⚠ Caution A gate valve is highly recommended for a contaminant drain line.

⚠ Caution Contaminant drain line must be assembled below the coolant surface level as shown on figure 5, to ensure that air doesn't enter the system.

Figure 5 : Recommended Piping Layout to Avoid Air Entering into the System.

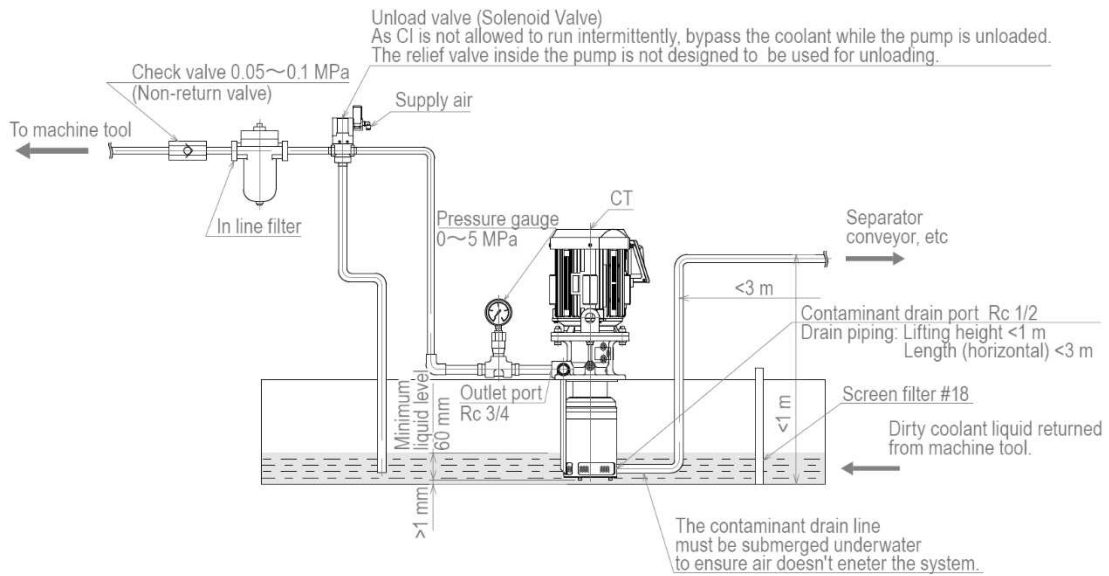

⚠ Caution Make sure there is no blocking or clogging in contaminant drain line.

⚠ Caution Do not return contaminant drain piping into the coolant tank.

Outlet Port

- Outlet line pipes must be as large as the outlet port diameter and pressure resistant type.
- Install a check valve in the outlet line near the port to reduce the time lag from motor start-up to coolant discharge and to prevent rust inside the pump.
- Pump and pipes must be filled with fluid at all times.

Piping for the Pump

●Torque Applied on Pipe Connection

* For pipe connections with NOP filter pump, follow the maximum permissible torques shown below

Table 3 : Maximum Permissible Torque by the Pipe Size

Pipe size, R	1/2"	3/4"
Torque N·m	25	30

 Caution Be sure to follow the instruction of torque control above.

 Caution Do not use liquid type sealant. Do not use sealant tape too much. Excess use of sealant tape may result in over-torque and damage the port.

●Connecting the Pipes

- To prevent leaks and air entry, make sure all pipe connections are securely tightened and completely sealed.
- Be sure to use pipe-supports so that the pipes are self-supported and no weight will be placed on the pump.
- Make sure that the pipe lengths and angles are correct when connected so that no unnecessary strain is placed on the pump.
- Installation of a pressure gauge is highly recommended as pump conditions can be easily monitored.
- Installation of a stop valve, union joints, and such other fittings are also recommended for easy maintenance.
- Some of the high-pressure hoses and other parts may have narrow internal diameters. Be sure to check not only the inner diameter of screw-in sections but the whole area of the pipe as well before use.
- Installation of an air vent circuit in the outlet line is recommended to avoid possible startup troubles.

●Pipes and Pipe Joints

Be sure to flush out all pipes to ensure that they are thoroughly cleaned before use.

 Caution Do not attempt to flush out piping if already assembled with the pump.

 Caution Airtight test must be completed before installation.

Electric Wiring

Electric wiring must be carried out by qualified personnel.

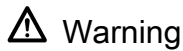

Warning

Make sure that the power is disconnected before beginning to work on wiring. Also take measures to avoid accidental power-on.



Warning

Be sure to follow the instruction of the motor wiring diagram to prevent fire and electrical leakage.



Warning

Ground the equipment properly to prevent fire and electrical shocks due to electrical leakage.

- Check the direction of the motor rotation. If using NOP's pre-installed motor (which is specially customized to work with NOP pump), the motor rotation is indicated on the wiring plate on the motor frame or terminal box. Connect the motor accordingly.
(Our NOP's pre-installed motor (a 3-phase type) is, when viewed from the suction side, designed to rotate in counter-clockwise if wired as illustrated in figure 6 below.)

Figure 6 : Motor Wiring Diagram



For Operation

•Start-up Checklist

- Is the tank filled with coolant up to, or over the specified level? (See Figure 4 P.8)
- Are the inlet, outlet and drain ports unblocked?
- Is there any loose sections in piping?
- On the initial startup, turn the pump on and off quickly to confirm that the motor is running in the correct direction.



Caution

Do not run the pump in reverse direction.

•Test Run



Caution

Do not run the pump dry over 10 seconds.



Caution

Be sure to bleed an outlet piping of air on a initial run.

Inspections

●Daily Startup Inspections

Check for coolant leakage, abnormal sound, and heating.

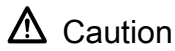

Caution

If any abnormalities are discovered, stop the pump immediately and inspect for the defective areas. (See Table 5, P.18)

●Periodical Inspections

- Periodical inspection must be performed at least once a year.

< Periodical inspection checklist >

- Flow rate, pressure in outlet port
- Flow rate in contaminant drain port (Guideline: 20 L/min, minimum)
- Clogging of contaminant drain port
- Clogging of the inlet port (perforated metal)
- Leaks from pipe connecting parts
- Minimum coolant level in the tank (Keep the level high enough to prevent air entry)
- Amount of contaminant in the tank (It is recommended to perform tank cleaning at least once in a half year)
- Concentration level of the coolant (Keep the level within the range specified by the coolant manufacturer)
- Fluid temperature (-5°C to +60°C)
- Over-heating of pump motor

Storage

- It is always good to keep replacement parts on hand (pump, motor and coupling) to minimize downtime due to unexpected pump failure or deterioration.
- Be sure to perform a periodical inspection.
(See “Periodical inspection” above)
- If the pump is to be stored for an extended period of time, take the following steps to protect the pump against the internal rust.
 - ① Pump lubricating oil of 15 mm²/s or less viscosity for three minutes to wet inside the pump.
 - ② Put lids on the ports, wrap the unit in a plastic bag, sealed it air-tight and store.
- If storing for six months or longer, check for exterior rust and free rotation once a month.
- If you reuse the pump long after storage, check for unusual noise, heating, and other abnormalities on the first run. When any of these mentioned above occurs, stop operation immediately.



Danger

Make sure that the power is disconnected before installation, maintenance or inspections to avoid the risk of electric shock.

Warranty

- NOP filter pump is warranted to be free from defects in workmanship and materials for **one year from the date we ship to customer's designated location, or 5000 hours of operation, whichever occurs first.**
- The warranty will not cover failures or damages caused by not following the guidelines stated in this manual, improper use, lack of appropriate maintenance, natural disaster, accidents or act of God.
- Any disassembly, alteration made to a product by the customer will void the warranty.
- The warranty will only apply to the products you purchased and not apply to indirect or consequential loss or damage resulting from the use of this product.

For Selecting a Pump

●Operating Method

- The pump is most suitable for continuous operation.

●Required Flow Rate

- Select a pump by referring to the catalog, drawings, or other materials.
- Note that discharge rate is subject to the pump type, temperature, and pressure of the fluid.
- Select a pump with an adequate margin of outlet pressure and flow rate.

●Required Pressure

- Select a pump by referring to the catalog, drawings and other material.
Note: The pump must be run within the maximum pump operating pressure and the motor output rating.

●Relief Valve Pressure Setting.

- The relief valve is preset at the cracking pressure.
Note: The relief valve setting must be within the maximum pump operating pressure and the motor output rating.
Note: The "cracking pressure" is the pressure at which relief valve starts to open with the pressure building up inside the circuit and allow certain amount of coolant to flow.

 Caution Do not run the pump over the maximum pressure setting.

 Caution Do not remove the return pipe, or it may cause foam and abnormal sounds.

●Selecting Coolant Type and Viscosity Range.

- Do not use coolant fluid that doesn't offer lubricity, rust protection (such as tap water) and contains corrosive substances. Also follow the table 4 on P.15 for the requirements of fluid viscosity and coolant type.

Table 4 : Compatible Coolant Type and Viscosity Range.

YTH-CT	Water soluble fluid · Up to 22 mm ² /s
---------------	---

Note: A lower viscosity will reduce volumetric efficiency (discharge will be reduced).

Note: Low temperature in winter must be taken into account when setting fluid temperature as viscosity increases rapidly when temperature decreases.

	Caution Consult your coolant manufacturer (or distributor) for the compatibility with fluoro carbon rubber, the material of our pump seal, in advance to prevent leakage.
---	--

	Warning The pump cannot be used for volatile liquids like gasoline, nor fuel oils like kerosene. They may explode or cause fire.
---	---

●Operating Ambient Temperatures

- The permissible ambient temperature range is from -10°C to +40°C.

	Caution Operate the pump within the specified temperature range
---	--

●Fluid Temperature Range

- The permissible temperature range of the tank fluid is from -5°C to +60°C.
- Keep the temperature gap between the tank fluid and ambient temperature within 40°C when start-up.

	Warning Do not pump fluid over the specified temperature range. Leaked fluid may cause burns.
---	--

	Caution Operating the pump over the specified range may significantly shorten the pump service-life and cause poor performance and coolant leakage.
---	--

●Compatible Work Materials.

	Caution Do not use work materials harder than HV300. Extremely hard materials, such as Inconel, Titanium alloys, Tungsten alloys, can drastically shorten your pump service-life.
---	--

	Caution Do not use materials containing Si over 6 %, such as Aluminum Die Cast (ADC), Ductile. Those materials can drastically shorten your pump service life.
---	---



Caution

Do not use hardened steel, carbon fiber, glass fiber contained materials, carbon materials. Those materials can drastically shorten your pump service-life.

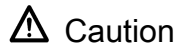

Caution

Do not use film or resin coated materials. Those materials can lead to poor filter performance and clogging in the cyclone filter.

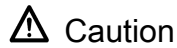

Caution

Do not operate the pump in a fluid containing a large amount of grindstones or abrasive grains. They can drastically shorten your pump service-life.

Motor Selection

• Required Power for the Pump.

- Select a pump with an adequate margin with reference to the performance curve in the catalog.
- The power required by a pump is subject to the pressure, flow rate and the viscosity of the fluid.
- A fluid with higher viscosity requires a greater power.

Note: Low temperature in winter must be taken into account when selecting motor, as viscosity rapidly increases when temperature drops.

• Voltage and Frequency



Caution

Do not apply wrong supply voltage or frequency.



Caution

Keep the motor rotation speed within the specified range.
(1000 min⁻¹ to 2000 mm⁻¹)

Suction Performance

CT is self-priming pump. However, resistance in inlet line or air entry can reduce the suction capability of the pump.

Always pay attention to the coolant surface level and clogging in inlet port (Perforated sheet metals).

⚠ Caution Make sure that there is no excess resistance in outlet line. It will affect the pump suction performance.

⚠ Caution Clean the perforations of the inlet port at regular intervals. Clogged inlet will cause abnormal noise, vibration, discharge failure, which result in the pump damage.

Internal Structure

Figure 7 : Sectional Views

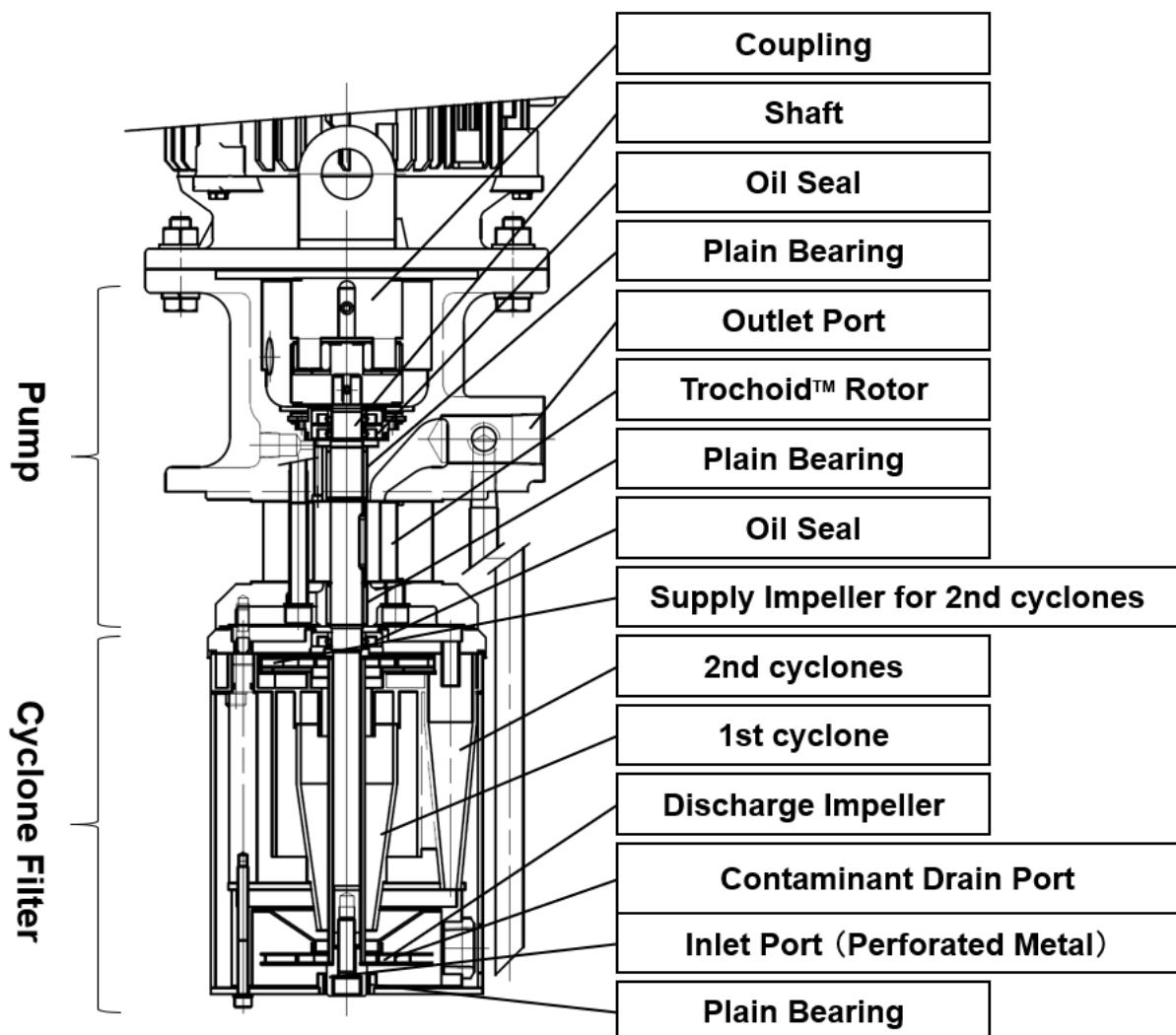

Troubleshooting Guide

If you experience no oil discharge, a high pitched sound, or such other abnormal phenomena soon after the installation, check the troubleshooting chart in the table that follows.

If you cannot find out the cause of trouble, consult us or your distributor.

Table 5 : Pump Troubleshooting Chart

Symptom	Possible causes	Check methods	Possible remedies
No discharge from outlet port. Insufficient flow or pressure. Abnormal noise.	Motor failure	Are wires at motor loose or disconnected? Do operation test for motor individually.	Repair or replace pump.
	Motor is wired incorrectly or disconnected	Are wires at motor loose or disconnected? Check direction of rotation.	Rewire motor in a correct rotation indicated on label.
	Coupling is damaged	Check connected area between pump and motor.	Replace coupling.
	Insufficient coolant level	Check coolant level in tank.	Add enough coolant. Control coolant level with level sensor.
	Inlet port is clogged	Check the inlet port for clogging.	Periodical cleaning around inlet port. Insert a plate filter prior to the inlet port as a pre-filtration.
	Impeller is clogged with metal chips, pump failure.	Check for impeller clogging or damage.	Remove metal chips. Repair or replace pump.
	Air drawn into pump or pipes.	On the first run, after long term storage or immediately after replacing coolant, pump often doesn't discharge due to air inside the pump.	Perform air-bleeding on pump or piping. If check valve is installed in outlet line, perform air-bleeding before check valve.
	Pump failure or wear	Does motor rotate? Are viscosity and lubrication level adequate? Is there abnormal noise?	Repair or replace motor. Change the types of coolant you use.
	Cavitation, Aeration	Is pump sucking foam or air?	Take measures to prevent suction of air or tramp oil. (ex. Change pump location, use partition or defoamer)
	Pipes connected to outlet port is too large.	Is outlet discharge flow rate sufficient?	· Use smaller pipes.
No discharge from contaminant drain port	Incorrect pressure setting in relief valve.	Does pressure build up when tightening the relief valve's adjust screw?	Tighten up the relief valve's adjust screw to the required level.
	Relief valve fixing	Does pressure not build up when tightening the relief valve's adjust screw?	Repair or replace relief valve. Remove tramp oil.
	Contaminant drain port piping is too long or too high.	Pull out a pipe from the contaminant drain port to see if coolant is delivered properly or not.	Piping must be no higher than 1 M from the tank bottom vertically, and no longer than 3 M horizontally.
Coolant leaks	Clogging of contaminant drain port.	Check the clogged area.	Clean inside the pipe periodically. Reduce the number of bends in pipe layout. Use larger pipe.
	Clogging or failure of suction impeller.	Check the suction impeller for clogging or damage.	Remove accumulated metal chips. Repair or replace pump.
Coolant leaks	Oil seal deteriorated or damaged	Does coolant leak from near the coupling connected area?	Repair or replace pump.
	gasket deteriorated or damaged.	Does coolant leak from connected area?	Repair or replace pump.

Breaker or thermal trips out.	Motor failure. Wiring errors.	Check motor wiring. Does motor start?	Rewire motor. Repair or replace motor.
	Overloading.	Are motor output rating and coolant viscosity adequate?	Use motor with higher output rating. Use pump with lower capacity. Lower the pressure setting. Change the coolant types.
	Coolant type is incompatible. (Viscosity is too high, lubricity insufficient, Pump failure)	Does motor rotate? Are coolant viscosity and lubricity adequate? Is there abnormal noise?	Repair or replace pump. Change the types of coolant you use.

NOP Nippon Oil Pump Co., Ltd.

Rev. No : CT202201EN

For further information :

HP : <https://www.nopgroup.com/english/>

Tel : +81-3-6402-4041

Fax : +81-3-3436-1777

Sumitomo Hamamatsucho Bldg. 8F,
1-18-16 Hamamatsucho, Minato-ku,
Tokyo, Japan 105-0013

Your dealer :